

Scribe Moulding

- MSW8** (1 - 8' pcs)
- MSW16** (2 - 8' pcs)
- MSW24** (3 - 8' pcs)
- MSW32** (4 - 8' pcs)
- MSW40** (5 - 8' pcs)
- MSW48** (6 - 8' pcs)
- MSW200** (25 - 8' pcs)

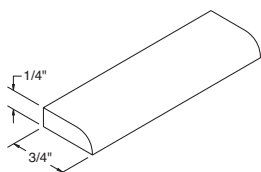

Outside Corner Moulding

90°

- MOCW8** (1 - 8' pcs)
- MOCW16** (2 - 8' pcs)
- MOCW24** (3 - 8' pcs)
- MOCW32** (4 - 8' pcs)
- MOCW40** (5 - 8' pcs)
- MOCW48** (6 - 8' pcs)
- MOCW200** (25 - 8' pcs)

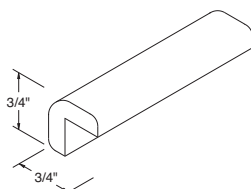

Outside Corner Moulding

135°

- MOC135-8** (1 - 8' pcs)

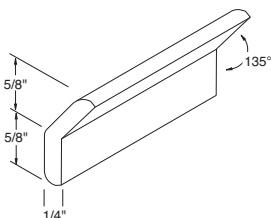

Triple Bead Moulding

- MTBEAD8** (1 - 8' pcs)
- MTBEAD16** (2 - 8' pcs)
- MTBEAD24** (3 - 8' pcs)

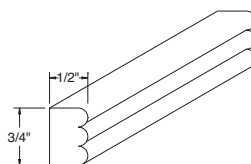

DESIGN SOLUTIONS

- ▶ Use the Outside Corner Moulding to create a finished look on ends of cabinet runs.
- ▶ Triple Bead Moulding can be used with Insert Crown Moulding.



Crown Moulding

- MCROWN8** (1 - 8' pcs)
- MCROWN16** (2 - 8' pcs)
- MCROWN24** (3 - 8' pcs)

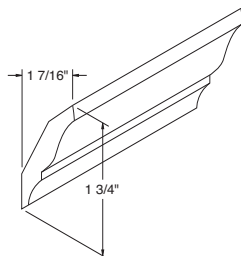

Insert

- MICROWN8** (1 - 8' pcs)
- MICROWN16** (2 - 8' pcs)
- MICROWN24** (3 - 8' pcs)

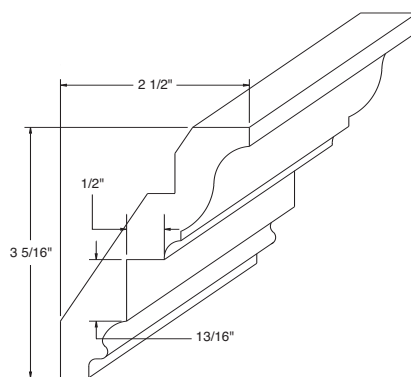

DESIGN SOLUTIONS

- ▶ For Moulding Solutions, see pages 40 & 41.
- ▶ Remember to order extra Mouldings when working with mitered corners.
- ▶ MICROWN is designed for inserts (i.e. dentil, rope, triple bead.)
- ▶ At minimum, leave a 3" reveal at the end of a run to allow Moulding and countertop ample clearance to return back to the wall.



Continued on next page.

DESIGN SOLUTIONS

- ▶ For Moulding Solutions, see pages 40 & 41.
- ▶ Remember to order extra Mouldings when working with mitered corners.
- ▶ At minimum, leave a 3" reveal at the end of a run to allow Moulding and countertop ample clearance to return back to the wall.



Crown Moulding (continued)

Full Overlay

- MFOLCR8** (1 - 8' pcs)
- MFOLCR16** (2 - 8' pcs)
- MFOLCR24** (3 - 8' pcs)

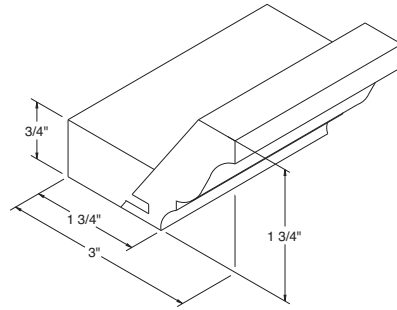

Tall

- MTCROWN8** (1 - 8' pcs)

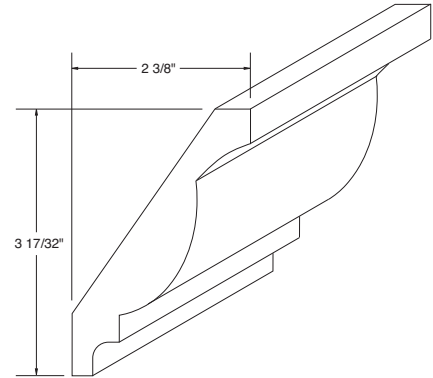

MOULDINGS AND TRIM

NOTES ✓

- ▶ MSHKRCROWN available in maple finishes only.

DESIGN SOLUTIONS

- ▶ For Moulding Solutions, see pages 40 & 41.
- ▶ Remember to order extra Mouldings when working with mitered corners.
- ▶ At minimum, leave a 3" reveal at the end of a run to allow Moulding and countertop ample clearance to return back to the wall.



Crown Moulding (continued)

Shaker

- MSHKRCROWN8** (1 - 8' pcs)
- MSHKRCROWN16** (2 - 8' pcs)
- MSHKRCROWN24** (3 - 8' pcs)

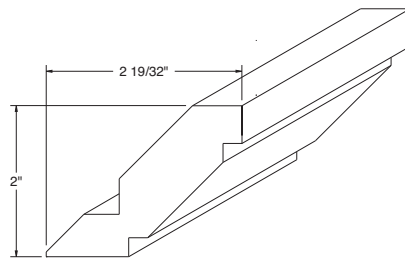

Small Cove

- MSMCOVECR8** (1 - 8' pcs) *New*

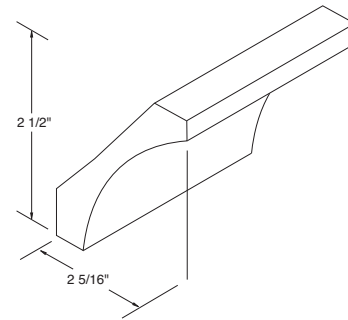

NOTES ✓

- ▶ Top-mount installation only (cleat is attached).

DESIGN SOLUTIONS

- ▶ MSTR is for use with stacked moulding designs for ease of installation of top mouldings.



Starter Moulding

- MSTR8** (1 - 8' pcs) *New*

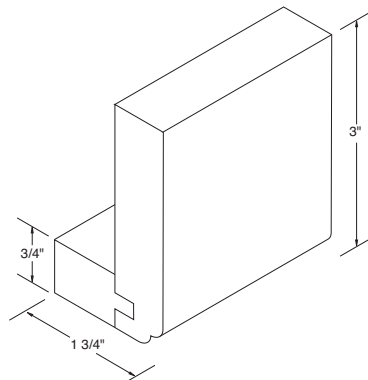

Soffit Filler Moulding

MSFM8 (1 - 8' pcs) *New*

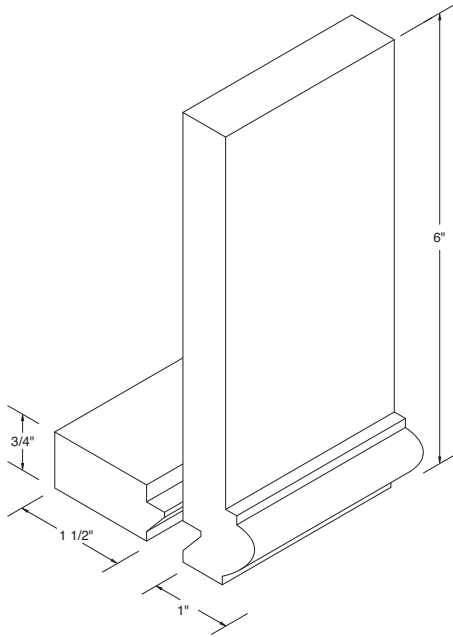

Counter Top Moulding

Radius

MCTR8 (1 - 8' pcs)
MCTR16 (2 - 8' pcs)
MCTR24 (3 - 8' pcs)

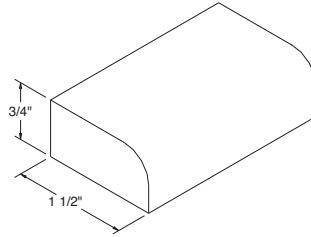

NOTES ✓

- ▶ MSFM cleat shipped unattached, can be top or face mounted.

DESIGN SOLUTIONS

- ▶ MSFM is for use with stacked moulding designs for ease of installation.



Counter Top Moulding (continued)

Bevel

MCTB8 (1 - 8' pcs)
MCTB16 (2 - 8' pcs)
MCTB24 (3 - 8' pcs)

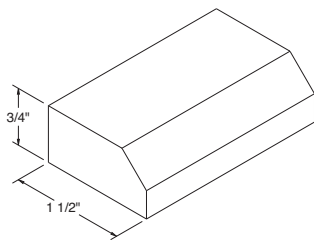

Ogee

MCTOG8 (1 - 8' pcs)
MCTOG16 (2 - 8' pcs)
MCTOG24 (3 - 8' pcs)

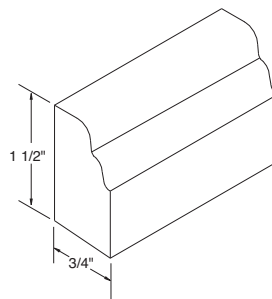

DESIGN SOLUTIONS

- ▶ MCTB can be flipped upside-down and used as top trim.





Cove Moulding

- MCV8** (1 - 8' pcs)
- MCV16** (2 - 8' pcs)
- MCV24** (3 - 8' pcs)
- MCV32** (4 - 8' pcs)
- MCV40** (5 - 8' pcs)
- MCV48** (6 - 8' pcs)
- MCV200** (25 - 8' pcs)

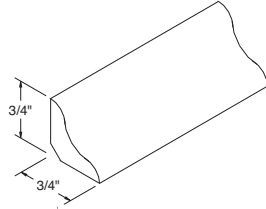

Quarter Round Moulding

- MQR8** (1 - 8' pcs)
- MQR16** (2 - 8' pcs)
- MQR24** (3 - 8' pcs)
- MQR32** (4 - 8' pcs)
- MQR40** (5 - 8' pcs)
- MQR48** (6 - 8' pcs)
- MQR200** (25 - 8' pcs)

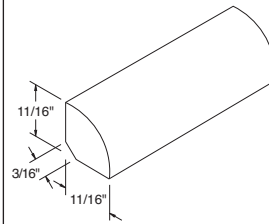

Batten Moulding

- MBAT8** (1 - 8' pcs)
- MBAT16** (2 - 8' pcs)
- MBAT24** (3 - 8' pcs)
- MBAT32** (4 - 8' pcs)
- MBAT40** (5 - 8' pcs)
- MBAT48** (6 - 8' pcs)

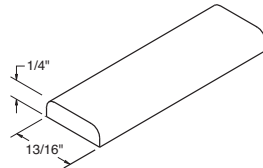

Traditional Soffit Trim Moulding

- MTST8** (1 - 8' pcs)
- MTST16** (2 - 8' pcs)
- MTST24** (3 - 8' pcs)

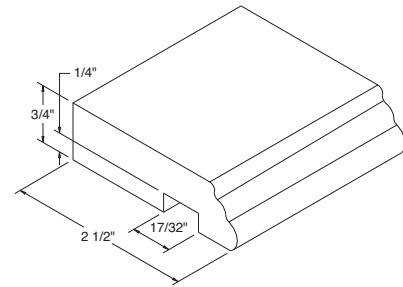

DESIGN SOLUTIONS

► MTCAP can be flipped upside-down and used as a base piece for a stacked top trim.



Traditional Cap Moulding

- MTCAP8** (1 - 8' pcs)
- MTCAP16** (2 - 8' pcs)
- MTCAP24** (3 - 8' pcs)

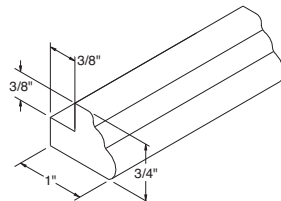

Tall Light Rail Moulding

- MTLR8** (1 - 8' pcs)
- MTLR16** (2 - 8' pcs)
- MTLR24** (3 - 8' pcs)

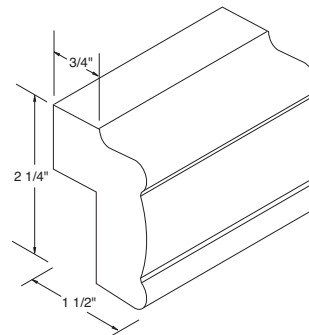

Light Rail Moulding

- MLR8** (1 - 8' pcs)
- MLR16** (2 - 8' pcs)
- MLR24** (3 - 8' pcs)

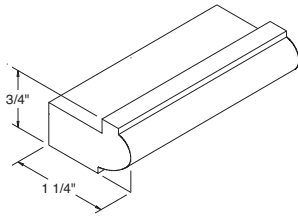

Traditional Trim Moulding

- MTT8** (1 - 8' pcs)
- MTT16** (2 - 8' pcs)
- MTT24** (3 - 8' pcs)

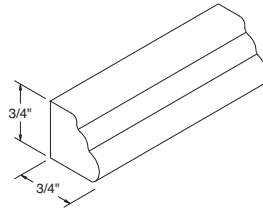

DESIGN SOLUTIONS

- ▶ MLR is designed to mount under the face frame of Wall Cabinets.



Traditional Batten Moulding

- MTBAT8** (1 - 8' pcs)
- MTBAT16** (2 - 8' pcs)
- MTBAT24** (3 - 8' pcs)

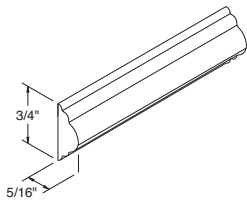

Dentil Moulding

- MDENTIL8** (1 - 8' pcs)
- MDENTIL16** (2 - 8' pcs)
- MDENTIL24** (3 - 8' pcs)

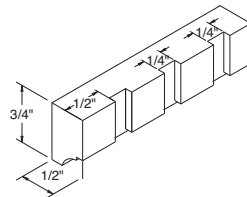

DESIGN SOLUTIONS

- ▶ MTBAT can be used with Insert Crown Moulding.
- ▶ MDENTIL can be used with Insert Crown Moulding.



Rope Moulding

- MROPE8** (1 - 8' pcs)
- MROPE16** (2 - 8' pcs)
- MROPE24** (3 - 8' pcs)

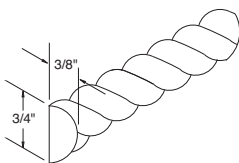

Base Shoe Moulding

- MBS8** (1 - 8' pcs)
- MBS16** (2 - 8' pcs)
- MBS24** (3 - 8' pcs)

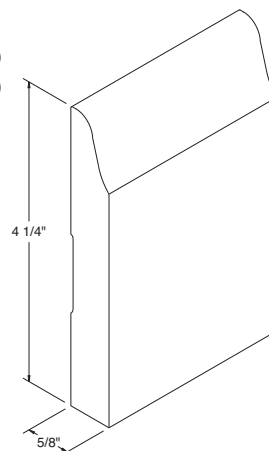

DESIGN SOLUTIONS

- ▶ MROPE can be used with Insert Crown Moulding.



NOTES ✓

- ▶ FBC3X3 Overlays available for Briarcliff, Durham, Eastland, Ellsworth, Monroe, Nantucket, and Wentworth. Must order separately under OL3X3 code.
- ▶ All Fillers finished on front and two long edges, except for F531A45 and BLVDFF331 which are finished on both sides and both long edges.
- ▶ All Fillers are 3/4" thick.
- ▶ FBC3X3 - Base Corner Filler with Toekick attached.
- ▶ F330 - 3" wide Filler.
- ▶ F331 - 3" wide Filler.
- ▶ F342 - 3" wide Filler.
- ▶ F631 - 6" wide Filler.
- ▶ F642 - 6" wide Filler.
- ▶ F380 - Utility 3" wide Filler.
- ▶ F392 - Utility 3" wide Filler.
- ▶ F680 - 6" wide Filler.
- ▶ F692 - 6" wide Filler.
- ▶ FF331 - 3" wide Reeded Filler.
- ▶ FF396 - 3" wide Reeded Filler.
- ▶ FFL331 - 3" wide Fluted Filler.
- ▶ FFL396 - 3" wide Fluted Filler.
- ▶ FFL631 - 6" wide Fluted Filler.
- ▶ FFL696 - 6" wide Fluted Filler.
- ▶ BLVDFF331 - 45° reversible angled Filler (fluted one side). Comes as a pair. Reversible, finished on back.
- ▶ F531A45 - 45° reversible decorative angled Filler (fluted one side). Comes as a pair. Trimmable 2" top and bottom. Reversible, finished on back.
- ▶ TKF3 - Toekick Filler. Order under style #010.

Fillers

- FBC3X3**
- F330**
- F331**
- F342**
- F631**
- F642**
- F380**
- F392**
- F680**
- F692**
- FF331**
- FF396**
- FFL331**
- FFL396**
- FFL631**
- FFL696**
- BLVDFF331** (pair)
- F531A45** (pair)
- TKF3**

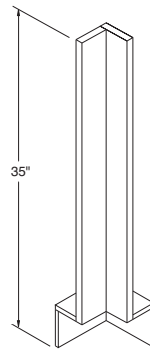

FBC3X3

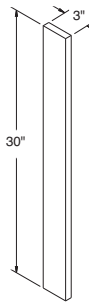

F330

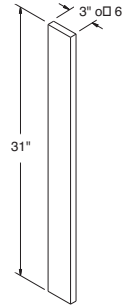

F331 & F631

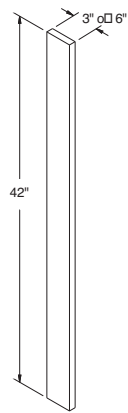

F342 & F642

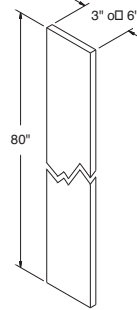

F380 & F680

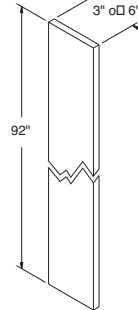

F392 & F692

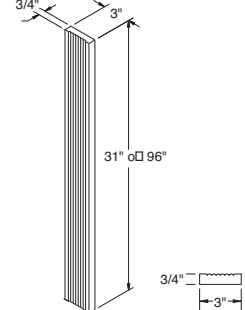

FF331 & FF396
(3" Reeded Fillers)

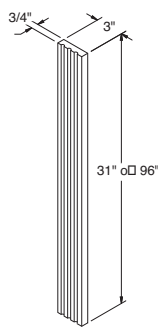

FFL331 & FFL396
(3" Fluted Fillers)

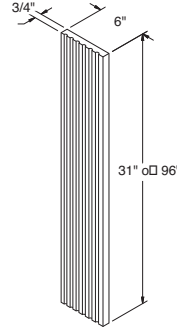

FFL631 & FFL696
(6" Fluted Fillers)

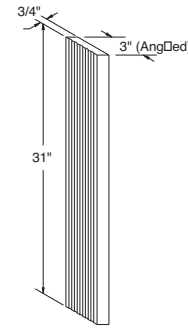

BLVDFF331 (pair)
(Angled Fluted/
Plain Filler)

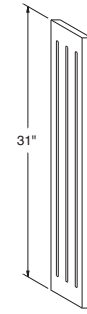

F531A45 (pair)
(Decorative Angled
Fluted/Plain Filler)

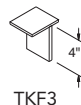

TKF3



Overlays*

	Use For
OL3X3	2" x 30 1/8" & 2 3/4" x 30 1/8" FBC3X3 Base Corner Filler
OL12	2 1/4" x 11 1/2" 12" High Wall
OL14	2 1/4" x 13 1/2" 14" High Wall
OL18	2 1/4" x 17 1/2" 18" High Wall
OL24	2 1/4" x 23 1/2" 24" High Wall
OL26	2 1/4" x 25 1/2" 30" High Vanity
OL30	2 1/4" x 29 1/2" 30" High Wall
OL31	2 1/4" x 30 1/8" 35" High Base/Vanity
OL335	2 1/4" x 30 1/8" PEPR335 Panels (page 172)
OL36	2 1/4" x 35 1/2" 36" High Wall
OL42	2 1/4" x 41 1/2" 42" High Wall
OL80	2 1/4" x 79 1/2" 84" High Utility
OL86	2 1/4" x 85 1/2" 90" High Utility
OL92	2 1/4" x 91 1/2" 96" High Utility

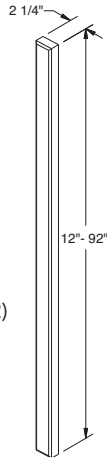

OL12-OL92

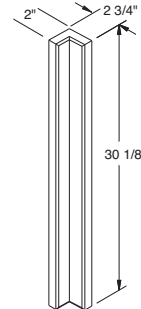

OL3X3

* Overlays are only available in Briarcliff, Durham, Eastland, Ellsworth, Monroe, Nantucket, and Wentworth.

NOTES

- ▶ The outside profile of the Overlay matches outside door profile.
- ▶ 3/4" thick.
- ▶ Order under door style number (ex. Nantucket Antique #201, Eastland Autumn #552).
- ▶ Use OL3X3 for FBC3X3 Base Corner Filler.
- ▶ Use OL12 for 12" high Wall.
- ▶ Use OL14 for 14" high Wall.
- ▶ Use OL18 for 18" high Wall.
- ▶ Use OL24 for 24" high Wall.
- ▶ Use OL26 for 30" high Vanity.
- ▶ Use OL30 for 30" high Wall.
- ▶ Use OL31 for 35" high Base/Vanity.
- ▶ Use OL335 for PEPR335 Panels (page 172).
- ▶ Use OL36 for 36" high Wall.
- ▶ Use OL42 for 42" high Wall.
- ▶ Use OL80 for 84" high Utility.
- ▶ Use OL86 for 90" high Utility.
- ▶ Use OL92 for 96" high Utility.

Split Turnings

REED96
SPOOL96
SPRINGEND

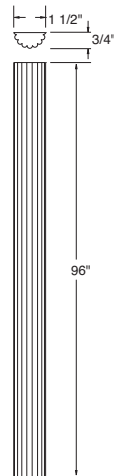

REED96
(each)

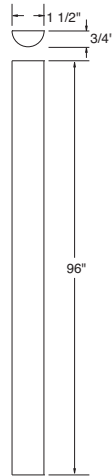

SPOOL96
(each)

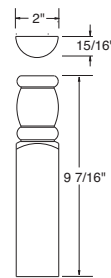

SPRINGEND
(pair)

NOTES

- ▶ SPTRINGEND is sold in pairs and are trimmable up to 5" each.



NOTES ✓

▶ Trimmable.



Decorative Legs and Feet

TKTLFOOT *New*

FRNLEG

TAPLEG

ISLEGSQ

ISLEG2S *New*

ISLEG4S *New*

DLEGMISION *New*

ENGLSICOLUMN *New*

RDLEG *New*

ENGBARCOLUMN *New*

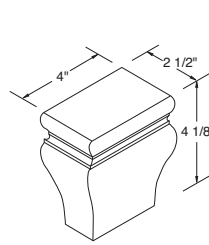

TOEKICK TULIP FOOT (TKTLFOOT)

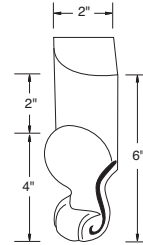

FRENCH LEG (FRNLEG)

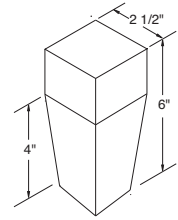

TAPERED LEG (TAPLEG)

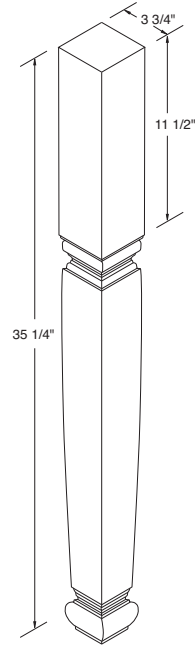

ISLAND LEG (ISLEGSQ)

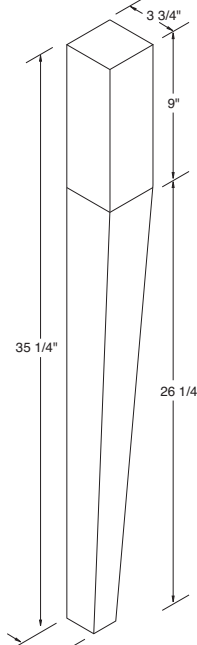

ISLAND LEG 2-SIDED (ISLEG2S)

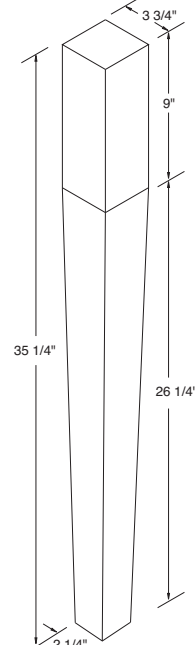

ISLAND LEG 4-SIDED (ISLEG4S)

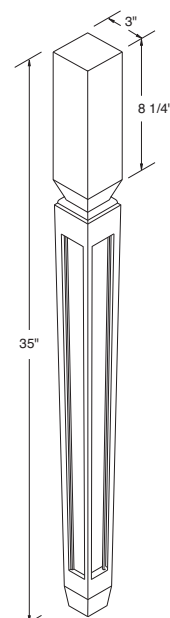

DECORATIVE MISSION LEG (DLEGMISION)

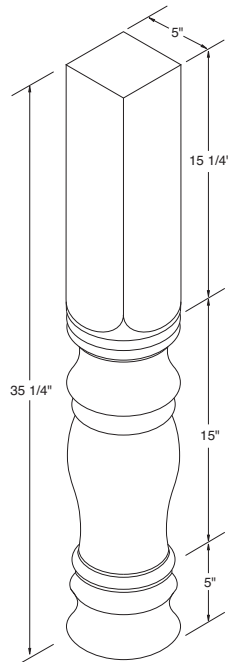

ENGLISH ISLAND COLUMN (ENGLSICOLUMN)

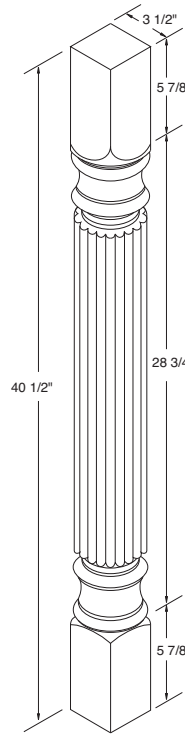

REED LEG (RDLEG)

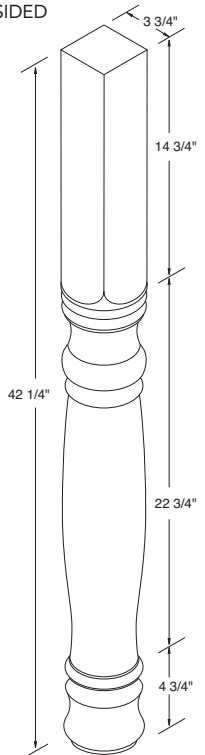

ENGLISH BAR COLUMN (ENGBARCOLUMN)

Rosette

FFROS3X3

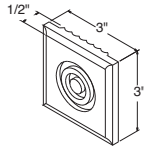

Mission Rosette

ROSETTEMIS *New*

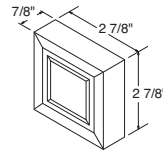

NOTES ✓

▶ FFROS3X3 grooved to fit FFs.



Corbels, 9" & 13" High

SMCORBEL

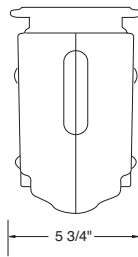
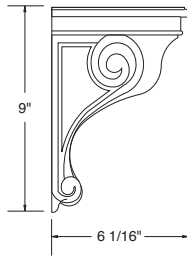

NOTES ✓

▶ In order to support substantial weight, Corbels must be properly installed with the attachment screws driven into a stud wall.



LGCORBEL

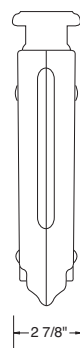
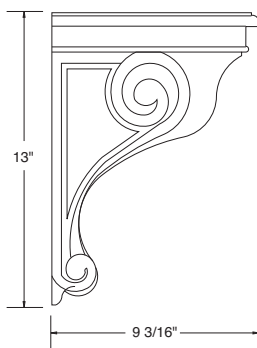

NOTES ✓

- ▶ In order to support substantial weight, Corbels must be properly installed with the attachment screws driven into a stud wall.



Mission Corbels, 6" & 9" High

CORBELMIS6 *New*
CORBELMIS9 *New*

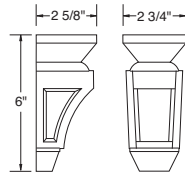

CORBELMIS6

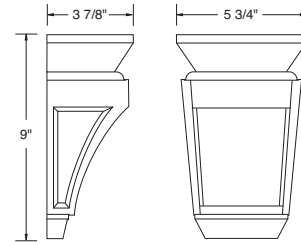

CORBELMIS9

NOTES ✓

- ▶ In order to support substantial weight, Corbels must be properly installed with the attachment screws driven into a stud wall.



Art Corbel, 9" High

CORBELART9 *New*

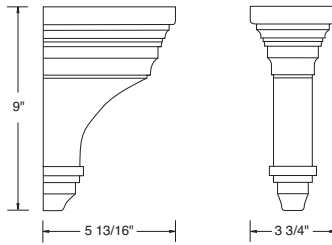

NOTES ✓

- ▶ Finished on all sides (reversible).
- ▶ Not intended to be used as a freestanding shelf support.
- ▶ VCORBEL sold in pairs.
- ▶ VCORBEL is 3/4" thick.
- ▶ VCORBEL11 has a 3" wide back plate.

DESIGN SOLUTIONS

- ▶ Use VCORBEL with English Country Valances.



Valance Corbels, 4" & 9 1/4" High

VCORBEL
VCORBEL11

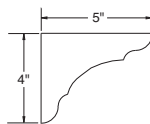

VCORBEL
(pair)

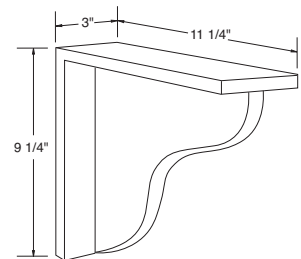

VCORBEL11

Acanthus Overlay

ACOVLY

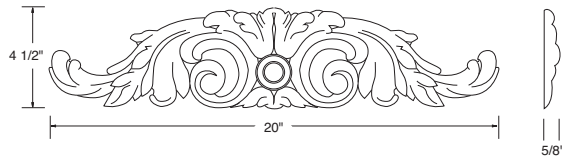

DESIGN SOLUTIONS

- ▶ Can be added to all Wood Hoods, except Canopy Wood Hood Arch (WHCA), for decorative embellishment. (See page 71).



Acanthus Ornament

ACO

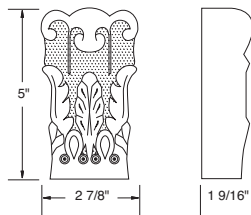

Valances Scalloped, 4 5/16" High

**V549SC
V561SC
V573SC**



	Length
V549SC	49"
V561SC	61"
V573SC	73"

NOTES

- ▶ 3/4" thick.
- ▶ Trimmable up to 1/2" on each side: 1" overall.
- ▶ Valances not finished on back or ends.



NOTES ✓

- ▶ 3/4" thick.
- ▶ Valances not finished on back or ends.



Valances Arch, 5" High

- V525RA**
- V531RA**
- V537RA**
- V543RA**
- V549RA**
- V561RA**
- V573RA**

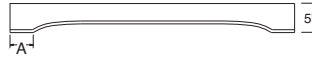

	A =	Length
V525RA	4 1/4"	25"
V531RA	4 1/4"	31"
V537RA	4 1/4"	37"
V543RA	4 1/2"	43"
V549RA	4 1/2"	49"
V561RA	6"	61"
V573RA	6 3/4"	73"

NOTES ✓

- ▶ 3/4" thick.
- ▶ Valances not finished on back or ends.



Valances Straight, 5" High or 8 7/8" High

- V531ST**
- V537ST**
- V540ST**
- V543ST**
- V546ST**
- V549ST**
- V561ST**
- V573ST**
- V937ST**
- V949ST**
- V961ST**
- V973ST**



V531ST-V573ST



V937ST-V973ST

	Length
V531ST	31"
V537ST	37"
V540ST	40"
V543ST	43"
V546ST	46"
V549ST	49"
V561ST	61"
V573ST	73"
V937ST	37"
V949ST	49"
V961ST	61"
V973ST	73"

Valances English Country, 5" High

V525EC
V537EC
V549EC
V585EC



	Cut Out	Length
V525EC	8 15/16"	25"
V537EC	16 7/16"	37"
V549EC	31 3/8"	49"
V585EC	46 1/4"	85"

NOTES ✓

- ▶ 3/4" thick.
- ▶ Valances not finished on back or ends.



Frieze Rails, 4 3/4" High

FR513
FR516
FR519
FR522
FR528
FR534
FR540

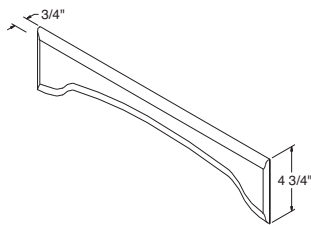

NOTES ✓

- ▶ Frieze Rail is attached to face frame with angle brackets (included).
- ▶ Outside edge profiled.
- ▶ FR513 – for 15" wide WOL/BOL Wall cabinets.
- ▶ FR516 – for 18" wide WOL/BOL Wall cabinets.
- ▶ FR519 – for 21" wide WOL/BOL Wall cabinets.
- ▶ FR522 – for 24" wide WOL and Bookcase cabinets.
- ▶ FR528 – for 30" wide WOL and Bookcase cabinets.
- ▶ FR534 – for 36" wide WOL, Bookcase, and Activity Center cabinets.
- ▶ FR540 – for 42" wide Bookcase and Activity Center cabinets.



NOTES ✓

▶ PEPR overlays available in Briarcliff, Durham, Eastland, Ellsworth, Monroe, Nantucket, and Wentworth. Must order separately under OL335 product code. (See page 165.)

★When PEPRPLY1.535 is ordered in Rustic Finishes, rustic characteristics on Panel only.

★★PEPR335 has rustic characteristics on Filler only.

† PREPRP1.584 and PREPRP1.596 will be laminate when ordered in White and Antique styles. When ordered in Rustic Finishes, rustic characteristics on Panels only.



Panels

PDWP
PEPR1.535
PEPR335 ★★
PEPRPLY1.535 ★
PEPRPLY335
PREF2384
PREF2396
PREPRP1.584 †
PREPRP1.596 †
PREPR33096
PSFEP

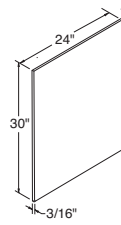

PDWP

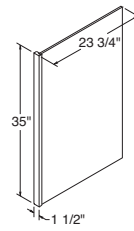

PEPR1.535
PEPRPLY1.535

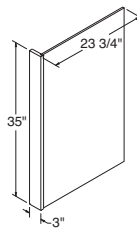

PEPR335
PEPRPLY335

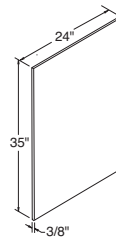

PSFEP

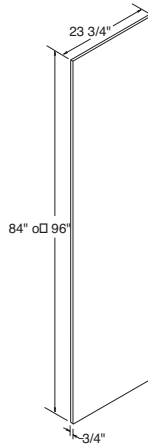

PREF2384
PREF2396

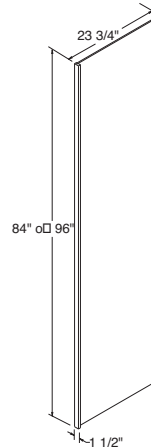

PREPRP1.584
PREPRP1.596

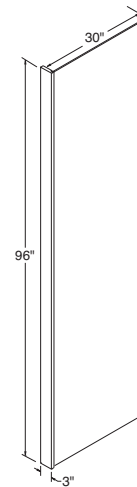

PREPR33096

Panel	Description	Size (T x W x H)	Edge Finish	Color Side 1	Color Side 2	Finish
PDWP	Dishwasher Front Panel	3/16" x 24" x 30"	None	Exterior	Raw	Veneer
PEPR1.535	Aristex® 3/8" End Panel w/1 1/2" Stile	1 1/2" x 23 3/4" x 35"	Front Long	Exterior	Interior	Laminate
PEPR335 ★★	Aristex® 3/8" End Panel w/3" Stile	3" x 23 3/4" x 35"	Front Long	Exterior	Interior	Laminate
PEPRPLY1.535 ★	Plywood 3/8" End Panel w/1 1/2" Stile	1 1/2" x 23 3/4" x 35"	Front Long	Exterior	Interior	Veneer
PEPRPLY335	Plywood 3/8" End Panel/ Stile Complete	3" x 23 3/4" x 35"	Front Long	Exterior	Interior	Veneer
PREF2384	Veneered Furniture Board Plywood Refrigerator End Panel	3/4" x 23 3/4" x 84"	1 Long	Exterior	Exterior	Veneer
PREF2396	Veneered Furniture Board Plywood Refrigerator End Panel	3/4" x 23 3/4" x 96"	1 Long	Exterior	Exterior	Veneer
PREPRP1.584 †	Plywd. 3/8" Refrigerator End Panel w/1 1/2" Stile	1 1/2" x 23 3/4" x 84"	Front Long	Exterior	Exterior	Veneer
PREPRP1.596 †	Plywd. 3/8" Refrigerator End Panel w/1 1/2" Stile	1 1/2" x 23 3/4" x 96"	Front Long	Exterior	Exterior	Veneer
PREPR33096	Veneered Furniture Board Refrigerator 3/4" End Panel w/3" Stile	3" x 30" x 96"	Front Long	Exterior	Exterior	Veneer
PSFEP	Aristex® Sink End Panel	3/8" x 24" x 35"	None	Exterior	Interior	Laminate

Stock Panels

BP4896
PA4836
PA4896
PP9635 *
P4836
P4896

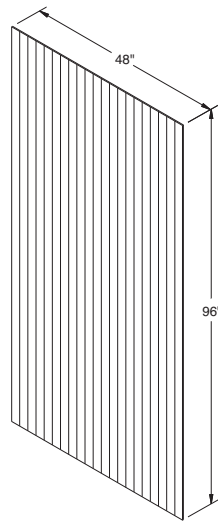

BP4896

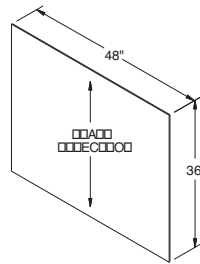

PA4836
P4836

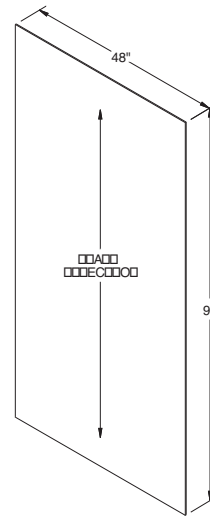

PA4896
P4896

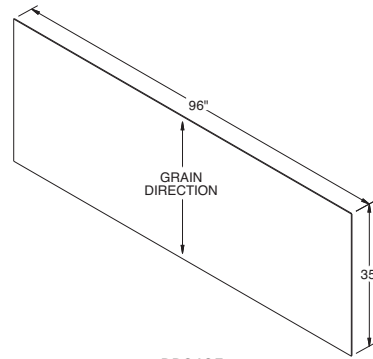

PP9635

NOTES ✓

*PP9635 is not available in White or Antique finishes.



Panel	Description	Size (T x W x H)	Edge Finish	Color Side 1	Color Side 2	Finish
BP4896	Beadboard Panel	3/16" x 48" x 96"	None	Exterior	Raw	Veneer
PA4836	Stock Panel - Aristex® Laminate	1/4" x 48" x 36"	None	Exterior	Raw	Laminate
PA4896	Stock Panel - Aristex® Laminate	1/4" x 48" x 96"	None	Exterior	Raw	Laminate
PP9635 *	Stock Panel - Veneer	3/16" x 96" x 35"	None	Exterior	Raw	Veneer
P4836	Stock Panel - Veneer	3/16" x 48" x 36"	None	Exterior	Raw	Veneer
P4896	Stock Panel - Veneer	3/16" x 48" x 96"	None	Exterior	Raw	Veneer

Veneer End Panels

EP1130 (2/ctn.)
EP1142 (2/ctn.)
EP1430 (2/ctn.)
EP1442 (2/ctn.)
EP2335 (2/ctn.)
EP2384 (2/ctn.)
EP2396 (2/ctn.)

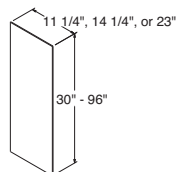

NOTES ✓

- ▶ End Panels are shipped two per carton.
- ▶ EP1430 and EP1442 are sized for 15" deep cabinets.



Panel	Description	Size (T x W x H)	Edge Finish	Color Side 1	Color Side 2	Finish
EP1130	Wall End Panel for 12" Depth	3/16" x 11 1/4" x 30"	None	Exterior	Raw	Veneer
EP1142	Wall End Panel for 12" Depth	3/16" x 11 1/4" x 42"	None	Exterior	Raw	Veneer
EP1430	Wall End Panel for 15" Depth	3/16" x 14 1/4" x 30"	None	Exterior	Raw	Veneer
EP1442	Wall End Panel for 15" Depth	3/16" x 14 1/4" x 42"	None	Exterior	Raw	Veneer
EP2335	Base End Panel	3/16" x 23" x 35"	None	Exterior	Raw	Veneer
EP2384	Utility End Panel	3/16" x 23" x 84"	None	Exterior	Raw	Veneer
EP2396	Utility End Panel	3/16" x 23" x 96"	None	Exterior	Raw	Veneer

NOTES ✓

- ▶ 1/4" thick panels with one-sided Aristex® laminate on exterior (no edge finish).
- ▶ One panel per package – NOT sold in pairs.
- ▶ EPA1430 and EPA1442 are sized for 15" deep cabinets.



Laminate End Panels (EPA Panels)

- EPA1130** (1/ctn.)
- EPA1142** (1/ctn.)
- EPA1430** (1/ctn.)
- EPA1442** (1/ctn.)
- EPA2335** (1/ctn.)
- EPA2384** (1/ctn.)
- EPA2396** (1/ctn.)

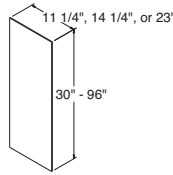

Panel	Description	Size (T x W x H)	Edge Finish	Color Side 1	Color Side 2	Finish
EPA1130	Wall End Panel for 12" Depth	1/4" x 11 1/4" x 30"	None	Exterior	Raw	Laminate
EPA1142	Wall End Panel for 12" Depth	1/4" x 11 1/4" x 42"	None	Exterior	Raw	Laminate
EPA1430	Wall End Panel for 15" Depth	1/4" x 14 1/4" x 30"	None	Exterior	Raw	Laminate
EPA1442	Wall End Panel for 15" Depth	1/4" x 14 1/4" x 42"	None	Exterior	Raw	Laminate
EPA2335	Base End Panel	1/4" x 23" x 35"	None	Exterior	Raw	Laminate
EPA2384	Utility End Panel	1/4" x 23" x 84"	None	Exterior	Raw	Laminate
EPA2396	Utility End Panel	1/4" x 23" x 96"	None	Exterior	Raw	Laminate

NOTES ✓

- ▶ DBEP and DPBEP include one door and one drawer front on an EP2335 Veneer End Panel and five screws for mounting.
- ▶ DBEPFH includes one door on an EP2335 Veneer End Panel and five screws for mounting.
- ▶ DBEPFH-12 includes one door on a Veneer Panel and five screws for mounting.
- ▶ DDWP includes one door, one Panel 24" x 30", and screws for installation. Shipped unassembled.
- ▶ DUEP includes two doors and one EP_ _ Veneer End Panel, and screws for assembly. Shipped assembled.
- ▶ DUEP includes three doors on miter styles.
- ▶ DVEP includes one door, one drawer front, and one Panel 20 1/4" x 30", and screws for assembly. Shipped assembled.
- ▶ DWEP parts include one door and an EP_ _ Veneer End Panel and four screws for mounting. Shipped assembled.
- ▶ Actual sizes of doors and drawer fronts will vary slightly by style. For exact dimensions, refer to parts dimension guide.
- ▶ Panel construction is the same for Standard, Select, and APC.

*Specify L or R on full overlay styles for all Decorative Panels except DDWP.



Decorative End Panels

- DBEP ***
- DBEPFH * *New***
- DBEPFH-12 ***
- DDWP**
- DPBEP ***
- DUEP84 ***
- DUEP90 ***
- DUEP96 ***
- DVEP ***
- DVEP35 ***
- DWEP30 ***
- DWEP36 ***
- DWEP42 ***
- DWEP1530 ***
- DWEP1536 ***
- DWEP1542 ***

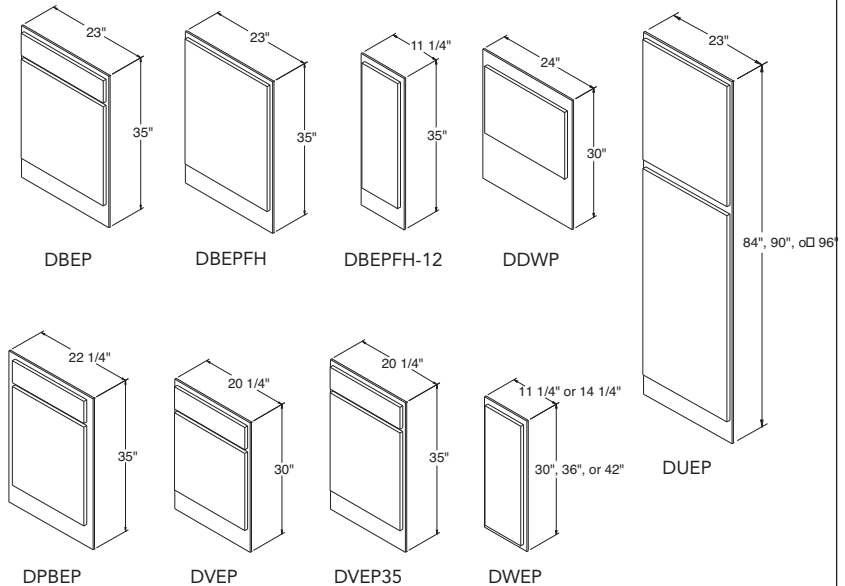

Panel	Description	Size (T x W x H)	Edge Finish	Color Side 1	Color Side 2	Finish
DBEP & DBEPFH *	Decorative Base End	3/16" x 23" x 35"	None	Exterior	Raw	Veneer
DBEPFH-12 *	Decorative Base End for 12" Depth	3/16" x 11 1/4" x 35"	None	Exterior	Raw	Veneer
DDWP	Decorative Dishwasher Front	3/16" x 24" x 30"	None	Exterior	Raw	Veneer
DPBEP *	Decorative Peninsula Base End	3/16" x 22 1/4" x 35"	None	Exterior	Raw	Veneer
DUEP84 *	Decorative Utility End	3/16" x 23" x 84"	None	Exterior	Raw	Veneer
DUEP90 *	Decorative Utility End	3/16" x 23" x 90"	None	Exterior	Raw	Veneer
DUEP96 *	Decorative Utility End	3/16" x 23" x 96"	None	Exterior	Raw	Veneer
DVEP *	Decorative Vanity End	3/16" x 20 1/4" x 30"	None	Exterior	Raw	Veneer
DVEP35 *	Decorative Vanity End	3/16" x 20 1/4" x 35"	None	Exterior	Raw	Veneer
DWEP30 *	Decorative Wall End	3/16" x 11 1/4" x 30"	None	Exterior	Raw	Veneer
DWEP36 *	Decorative Wall End	3/16" x 11 1/4" x 36"	None	Exterior	Raw	Veneer
DWEP42 *	Decorative Wall End	3/16" x 11 1/4" x 42"	None	Exterior	Raw	Veneer
DWEP1530 *	Decorative Wall End for 15" Depth	3/16" x 14 1/4" x 30"	None	Exterior	Raw	Veneer
DWEP1536 *	Decorative Wall End for 15" Depth	3/16" x 14 1/4" x 36"	None	Exterior	Raw	Veneer
DWEP1542 *	Decorative Wall End for 15" Depth	3/16" x 14 1/4" x 42"	None	Exterior	Raw	Veneer

End Panel Columns, Fluted

Wall

EPCWFL24
EPCWFL30
EPCWFL42

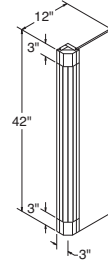
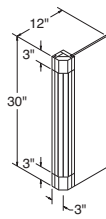
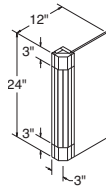

NOTES ✓

- ▶ All End Panel Columns feature an attached 3/8" laminate finished end panel.
- ▶ EPCWFLs are reversible and designed for use in Wall applications.
- ▶ EPCBFLs are designed for use in Base applications.
- ▶ EPCTFLs are designed for use in Tall applications.
- ▶ End Panel Columns are available in Cherry, Maple, and White/Antique finishes only.
- ▶ Field measure for countertops is recommended due to the unique profile on the end panel filler.

★Specify L or R to indicate panel location.



Base

EPCBFL31 ★
EPCBFL35 ★

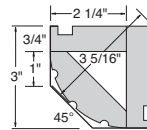
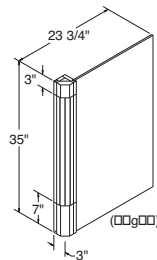
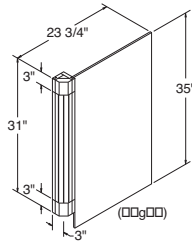

Tall

EPCTFL84 ★
EPCTFL90 ★
EPCTFL96 ★

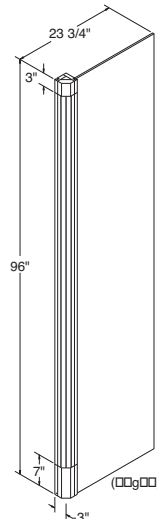
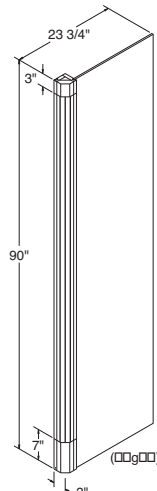
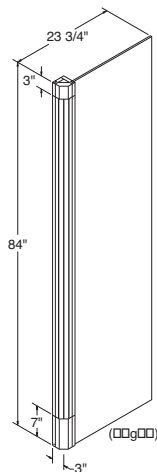

NOTES ✓

- ▶ All End Panel Columns feature an attached 3/8" laminate finished end panel.
- ▶ EPCWREs are reversible and designed for use in Wall applications.
- ▶ EPCBREs are designed for use in Base applications.
- ▶ EPCTREs are designed for use in Tall applications.
- ▶ End Panel Columns are available in Cherry, Maple, and White/Antique finishes only.
- ▶ Field measure for countertops is recommended due to the unique profile on the end panel filler.

★Specify L or R to indicate panel location.



End Panel Columns, Reeded

Wall

EPCWRE24
EPCWRE30
EPCWRE42

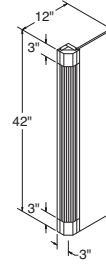
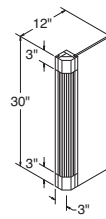
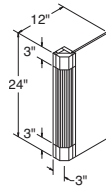

Base

EPCBRE31 ★
EPCBRE35 ★

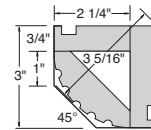
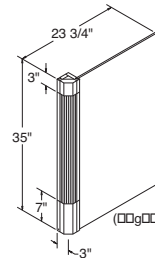
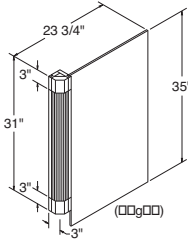

Tall

EPCTRE84 ★
EPCTRE90 ★
EPCTRE96 ★

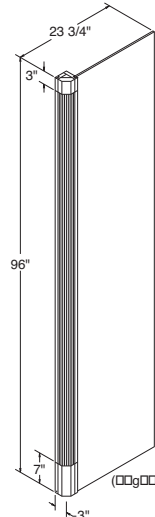
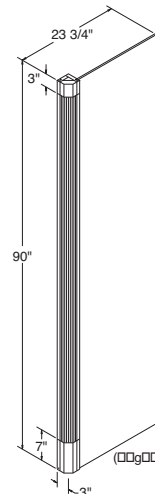
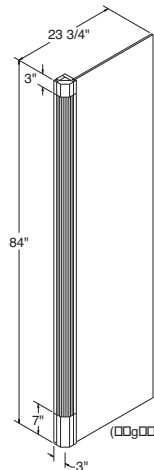

End Panel Columns, Round

Wall

EPCWRD24
EPCWRD30
EPCWRD42

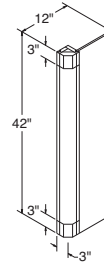
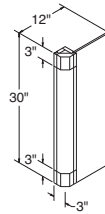
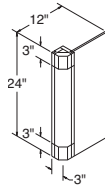

NOTES ✓

- ▶ All End Panel Columns feature an attached 3/8" laminate finished end panel.
- ▶ EPCWRDs are reversible and designed for use in Wall applications.
- ▶ EPCBRDs are designed for use in Base applications.
- ▶ EPCTRDs are designed for use in Tall applications.
- ▶ End Panel Columns are available in Cherry, Maple, and White/Antique finishes only.
- ▶ Field measure for countertops is recommended due to the unique profile on the end panel filler.

★Specify L or R to indicate panel location.



Base

EPCBRD31 ★
EPCBRD35 ★

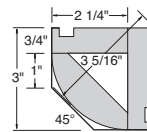
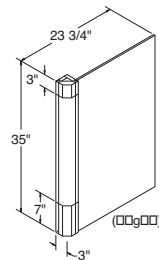
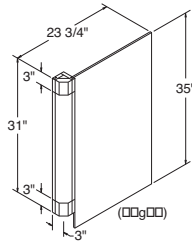

Tall

EPCTRD84 ★
EPCTRD90 ★
EPCTRD96 ★

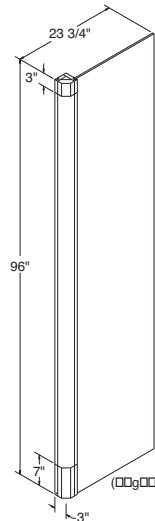
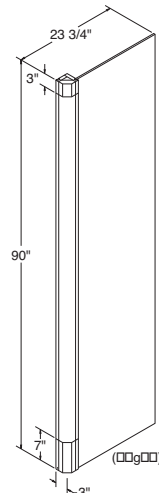
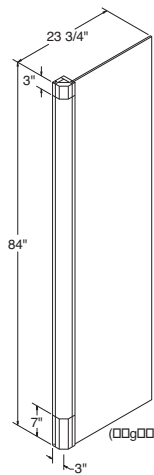

NOTES ✓

- ▶ Rail, Panel, and Toekick.
- ▶ 27" opening.

DESIGN SOLUTIONS

- ▶ Use drawer front to cover bottom portion of panel.



Range Panel, 35" High

RP30

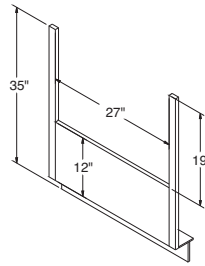

NOTES ✓

- ▶ Toekick dimension: 1/4" x 4" x 96"
- ▶ TOEKICK – 4 - 96" pieces, 1/4" thick, and 4" wide.
- ▶ TOEKICK8 – 1 - 96" piece, 1/4" thick, and 4" wide.



Toekick

**TOEKICK
TOEKICK8**

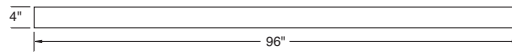

Item	Description	Size (T x W x H)	Edge Finish	Color Side 1	Color Side 2	Finish
TOEKICK	Aristex® Toekick	1/4" x 4" x 96"	None	Exterior	Raw	Laminate
TOEKICK8	Aristex® Toekick	1/4" x 4" x 96"	None	Exterior	Raw	Laminate

NOTES ✓

- ▶ TKC dimension: 3/4" x 4" x 3/4"
- ▶ Sold in pairs.



Toekick Cap

TKC

